

ASSEMBLY INSTRUCTION

7175-CP2406-B-2517



A	A1	A2	A3	B	C	D	
8 PCS	4 PCS	4 PCS	6 PCS	4 PCS	4 PCS	4 PCS	
F	H	I	J	K	L	M	N
16PCS	4PCS	1PC	4 PCS	48PCS	8PCS	24 PCS	2 PCS

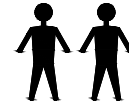
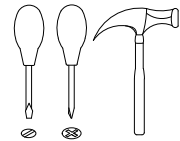

FIG. 1

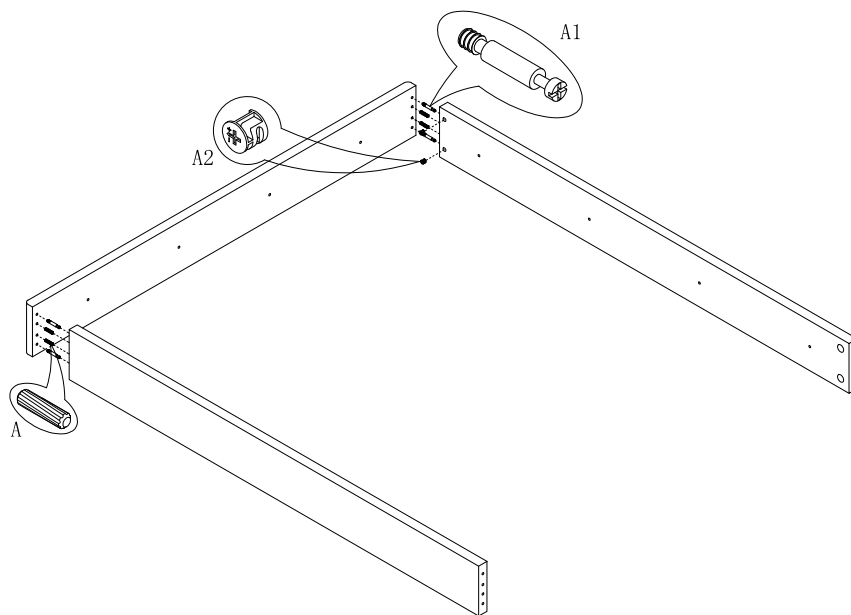
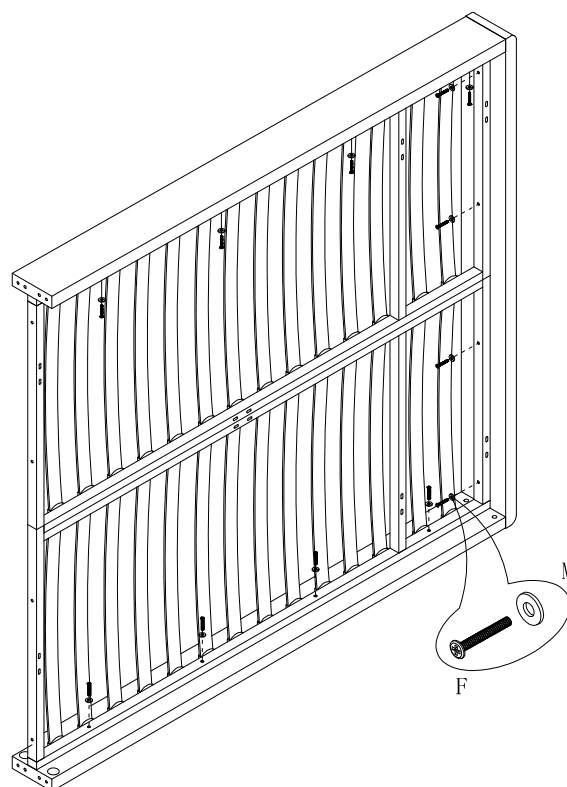

















FIG. 2



A	A1	A2	A3	B	C	D	
 Ø10*40	 Ø7*L30	 Ø15*H12		 5/16*L65	 5/16*H18	 Ø8*Ø14	
8 PCS	4 PCS	4 PCS	6 PCS	4 PCS	4 PCS	4 PCS	
F	H	I	J	K	L	M	N
 M6*45	 L200	 5	 Ø3.8*L50	 Ø3.5*L20	 5/16*L60	 Ø8*Ø18	
16PCS	4PCS	1PC	4 PCS	48PCS	8PCS	24 PCS	2 PCS

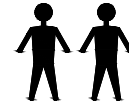
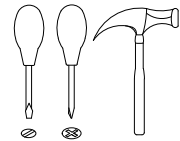

FIG. 3

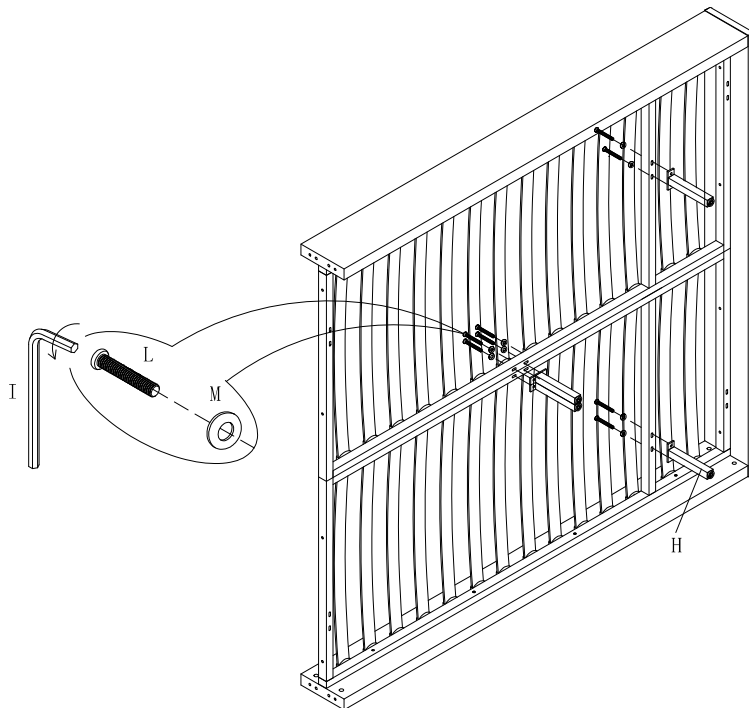
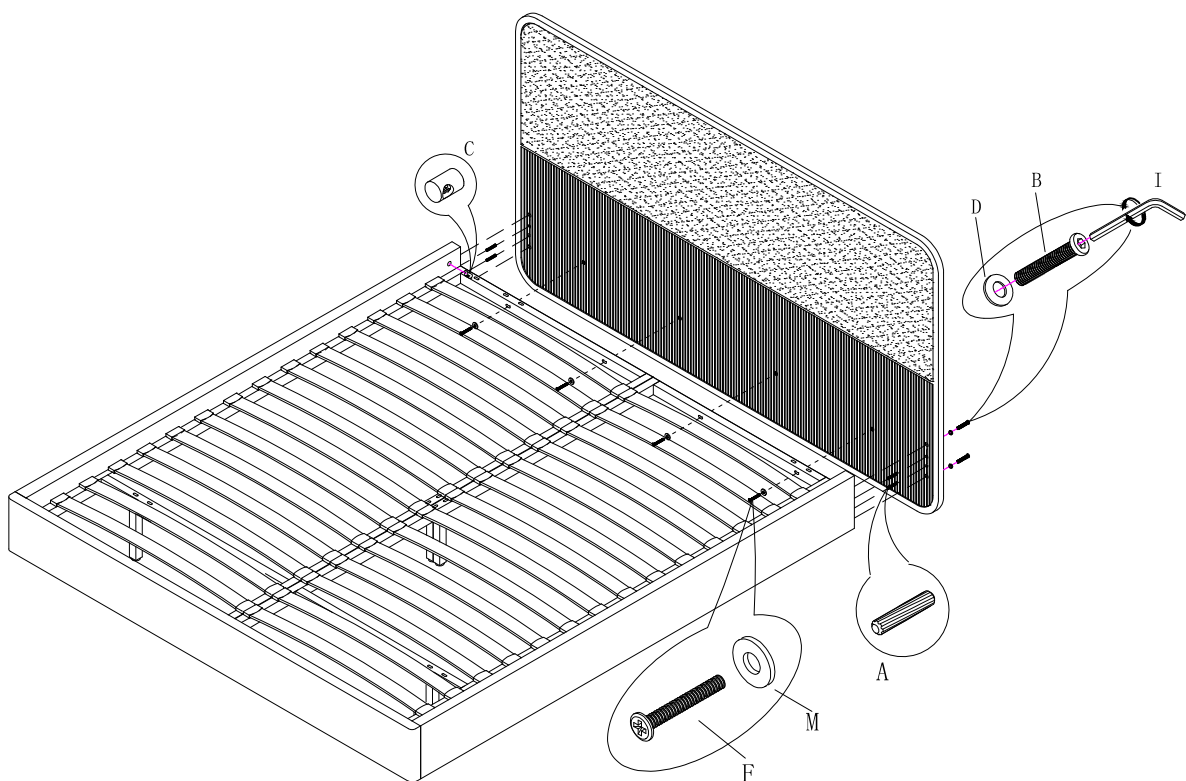

















FIG. 4



A	A1	A2	A3	B	C	D	
 $\phi 10 \times 40$	 $\phi 7 \times L30$	 $\phi 15 \times H12$		 $5/16 \times L65$	 $5/16 \times H18$	 $\phi 8 \times \phi 14$	
8 PCS	4 PCS	4 PCS	6 PCS	4 PCS	4 PCS	4 PCS	
F	H	I	J	K	L	M	N
 M6*45	 L200	 5	 $\phi 3.8 \times L50$	 $\phi 3.5 \times L20$	 $5/16 \times L60$	 $\phi 8 \times \phi 18$	
16 PCS	4 PCS	1 PC	4 PCS	48 PCS	8 PCS	24 PCS	2 PCS

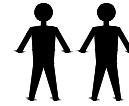
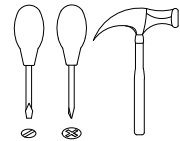

FIG. 5

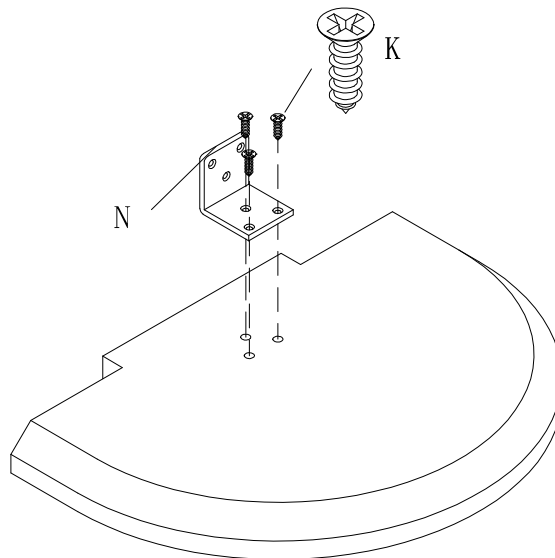
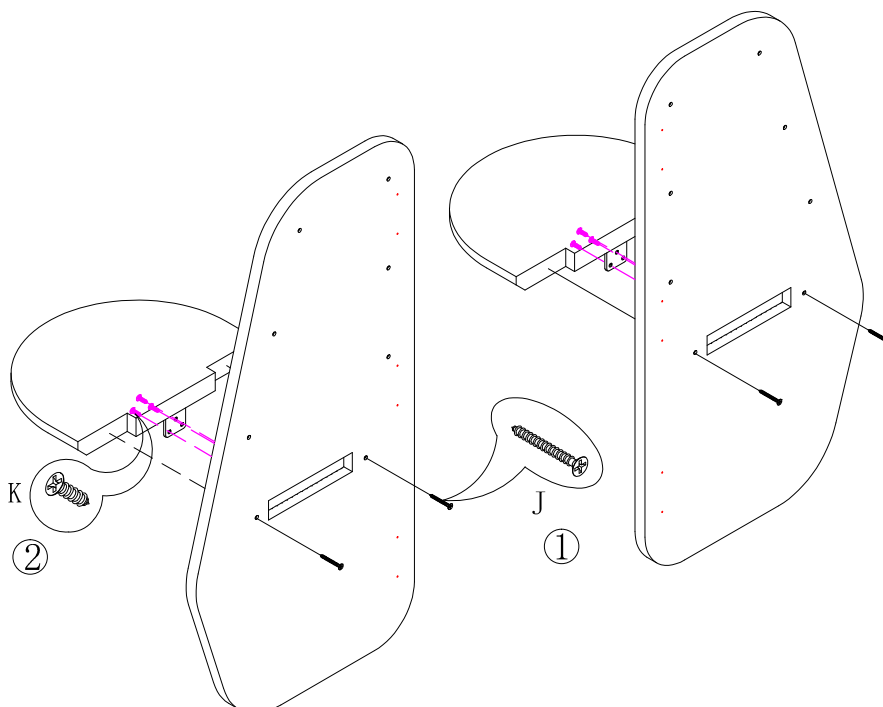

















FIG. 6



A	A1	A2	A3	B	C	D	
 ø10*40	 ø7*L30	 ø15*H12		 5/16*L65	 5/16*H18	 ø8*ø14	
8 PCS	4 PCS	4 PCS	6 PCS	4 PCS	4 PCS	4 PCS	
F	H	I	J	K	L	M	N
 M6*45	 L200	 5	 ø3.8*L50	 ø3.5*L20	 5/16*L60	 ø8*ø18	
16PCS	4PCS	1PC	4 PCS	48PCS	8PCS	24 PCS	2 PCS

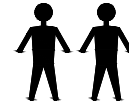
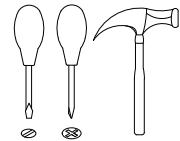

FIG.
7

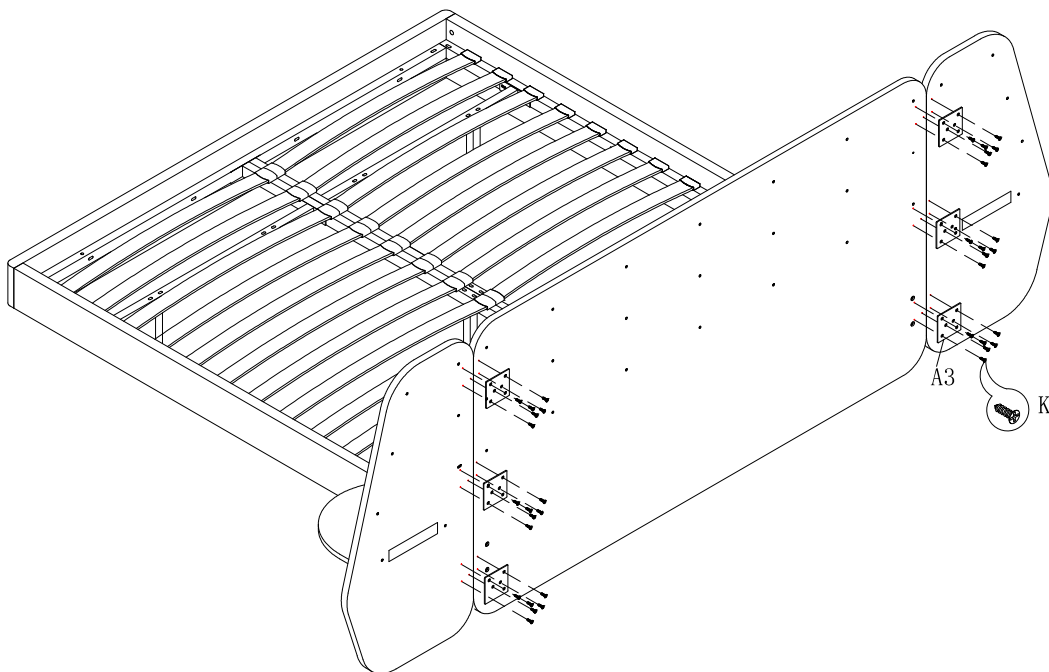

FIG.
8

