



C	Ø6		4
B	M6x60		4
A	4mm		1
NO.	SIZE	DIAGRAM	QTY

FIG.
1

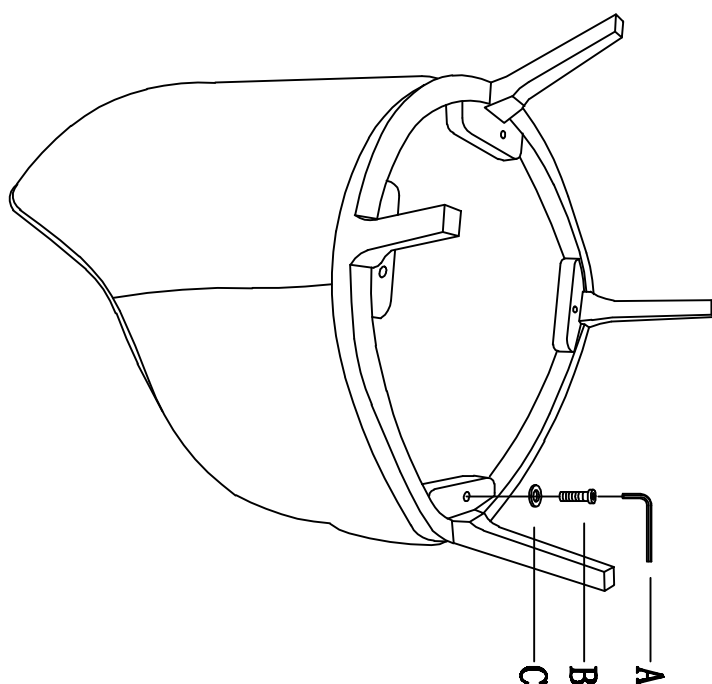

FIG.
2

